

Quantum Computers

Will they change the way in which we solve
(mathematical) problems in the future?

Dr. rer. nat. Matthias Möller
Assistant Professor, Numerical Analysis
Delft University of Technology
Delft Institute of Applied Mathematics



TU Delft

- 8 Faculties
- 16 Bachelor programmes
- 32 Master programmes
- 23,460 Students
- 2,800 PhD students
- 3,448 Scientific staff
- 253 Professors

DCSE

Enabling Technology for Industry



Quantum Computing at TU Delft

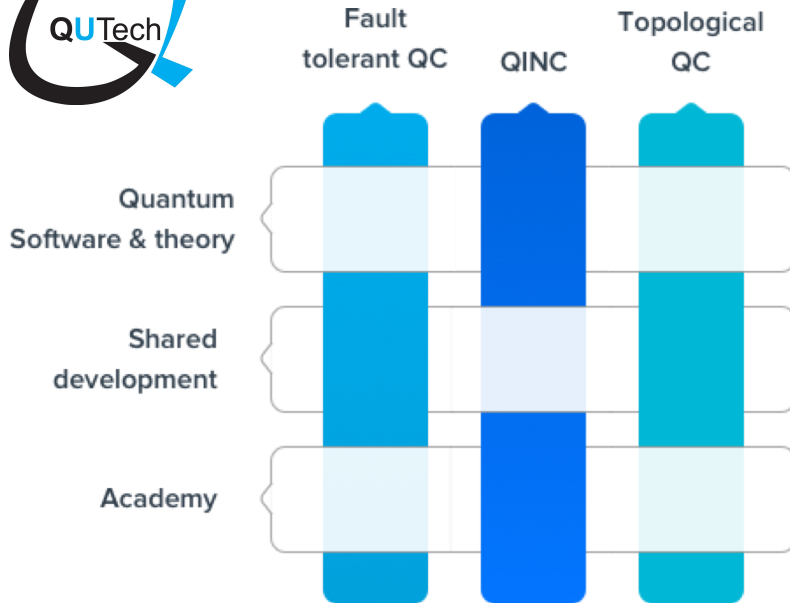

Delft
Institute of
Applied
Mathematics

quantum computing

encode optimization entanglement paradox teleportation reversible Bob classical measurement experiment bits Bloch Bell superposition state decoherence phase complexity EPR algorithm supremacy Alice gates states estimation correlations pure sphere qubit probability annealing amplitudes decode transportation accelerated QFT circuit

Outlook

- Basic Concepts of quantum computing
 - *Quantum bits, gates, and algorithms*
- Quantum-accelerated design optimization
 - *A conceptual framework*
- Practical aspects of quantum computing
 - *SDKs and good practices*
- Conclusion

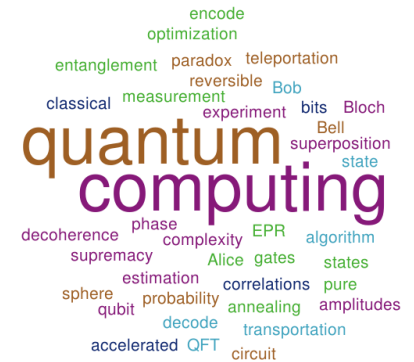

Basic concepts of quantum computing

QUANTUM BITS

From bits to quantum bits

- Classical bits

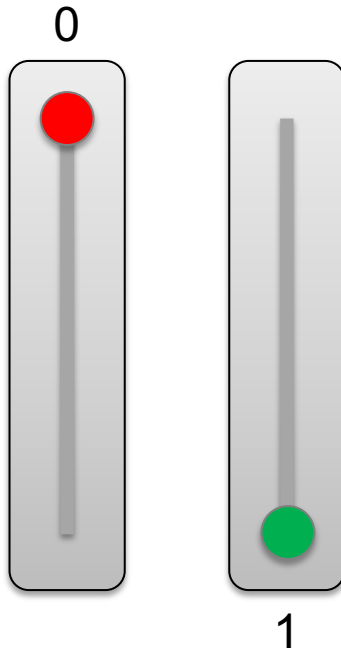

- Quantum bits (qubits)



From bits to quantum bits

- Classical bits

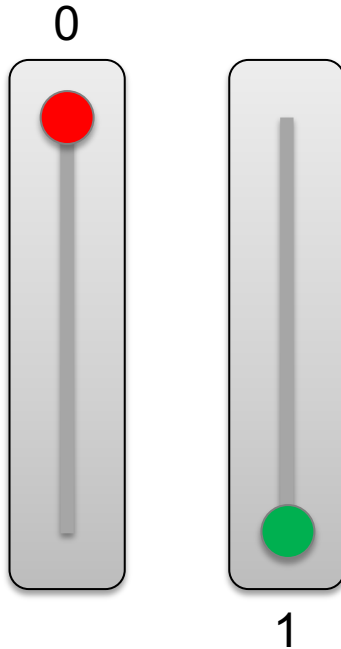

- Quantum bits (qubits)

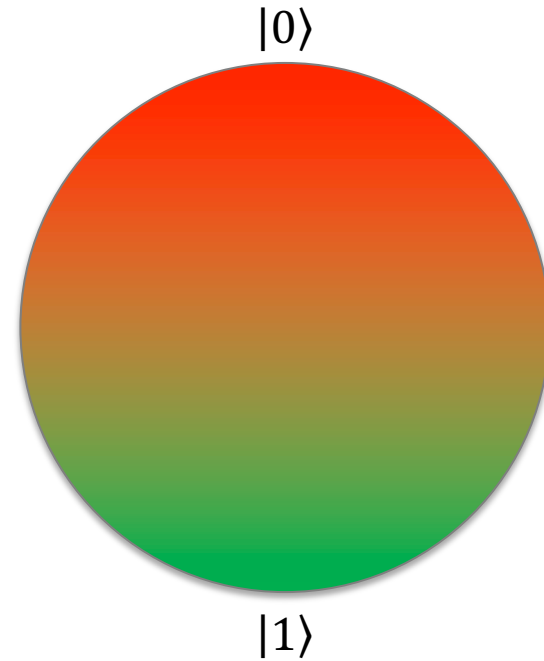

The Bloch sphere

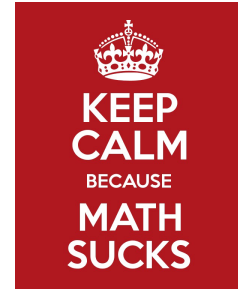

The Bloch sphere

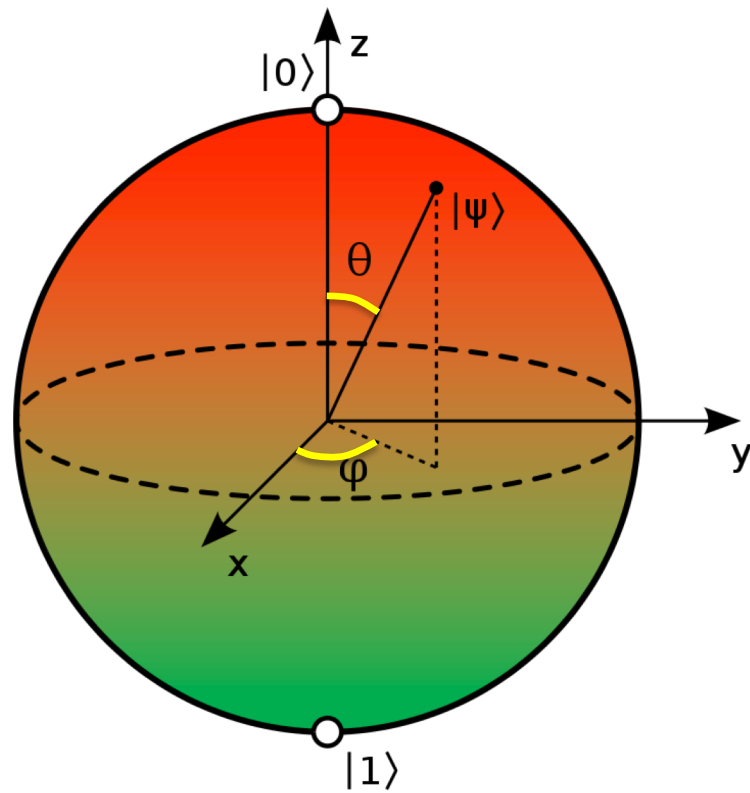

The Bloch sphere

- Quantum state

$$|\psi\rangle = \cos\frac{\theta}{2} \cdot |0\rangle + e^{i\varphi} \cdot \sin\frac{\theta}{2} \cdot |1\rangle$$

- Basis states $|0\rangle$ and $|1\rangle$
- Latitude $\theta \in [0, \pi]$
- Longitude $\varphi \in [0, 2\pi)$

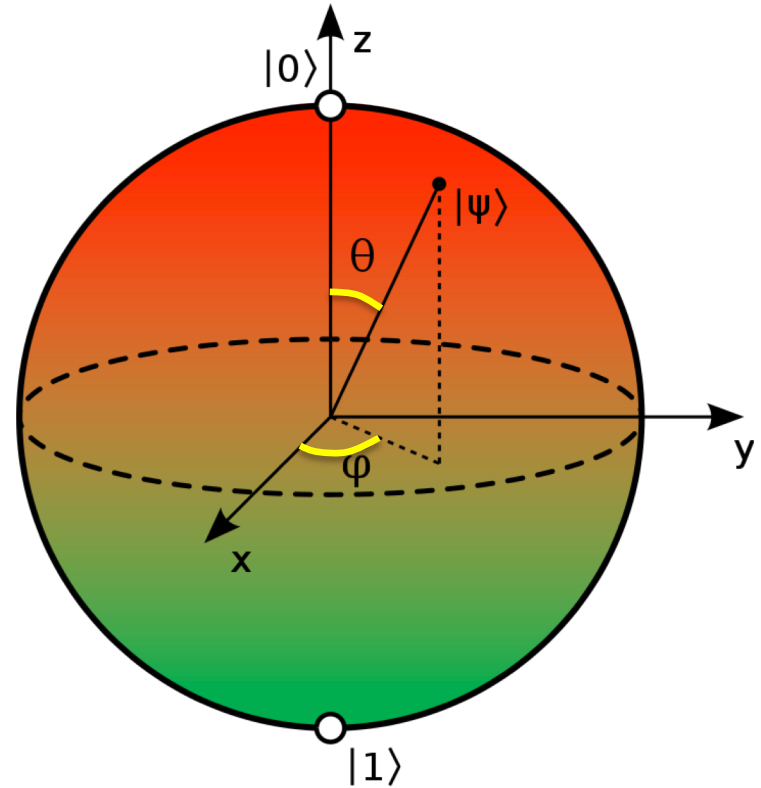

The Bloch sphere, cont'd

- $\theta = 0$ implies

$$|\psi\rangle = 1 \cdot |0\rangle + e^{i\varphi} \cdot 0 \cdot |1\rangle = |0\rangle$$

- $\theta = \pi$ implies

$$|\psi\rangle = 0 \cdot |0\rangle + e^{i\varphi} \cdot 1 \cdot |1\rangle = |1\rangle$$

- *Poles represent classical bits*

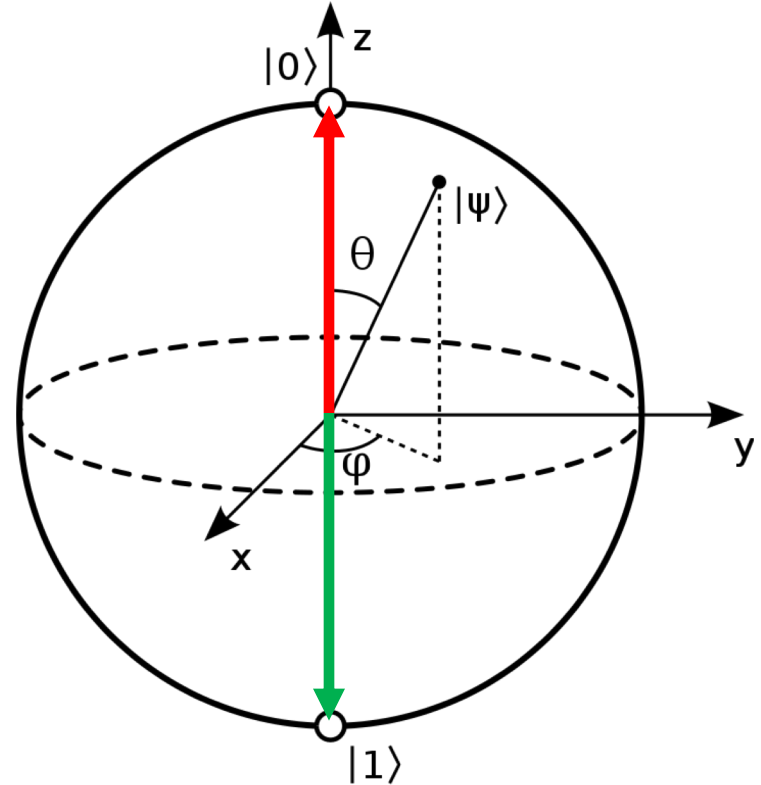

The Bloch sphere, cont'd

- $\theta = \frac{\pi}{2}$ and $\varphi = 0$ implies

$$|\psi\rangle = \frac{1}{\sqrt{2}} \cdot |0\rangle + \frac{e^{i0}}{\sqrt{2}} \cdot |1\rangle = \frac{|0\rangle + |1\rangle}{\sqrt{2}}$$

- $\theta = \frac{\pi}{2}$ and $\varphi = \pi$ implies

$$|\psi\rangle = \frac{1}{\sqrt{2}} \cdot |0\rangle + \frac{e^{i\pi}}{\sqrt{2}} \cdot |1\rangle = \frac{|0\rangle - |1\rangle}{\sqrt{2}}$$

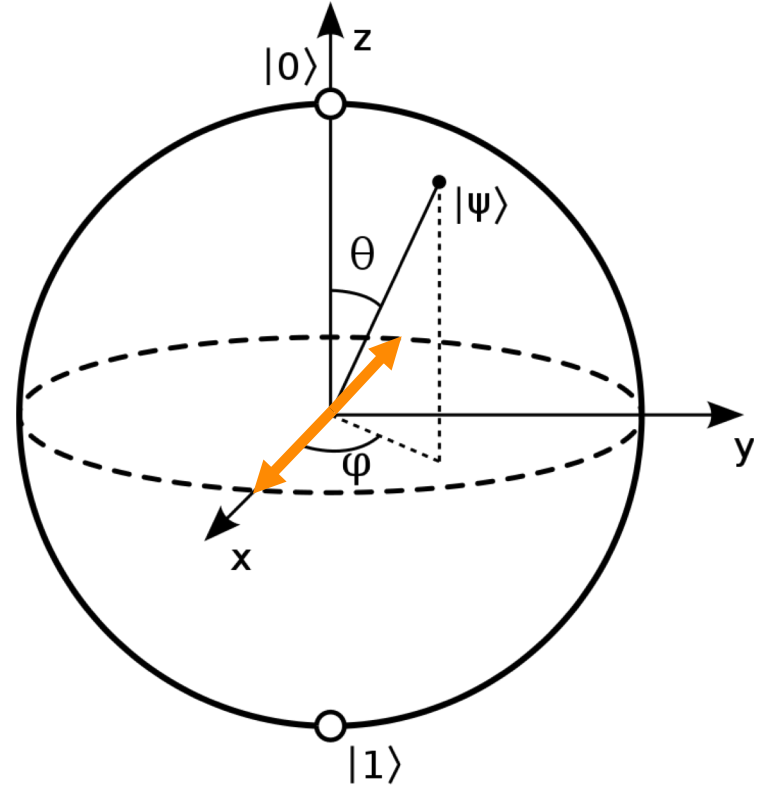

What to do with this added value?

- Classical bits

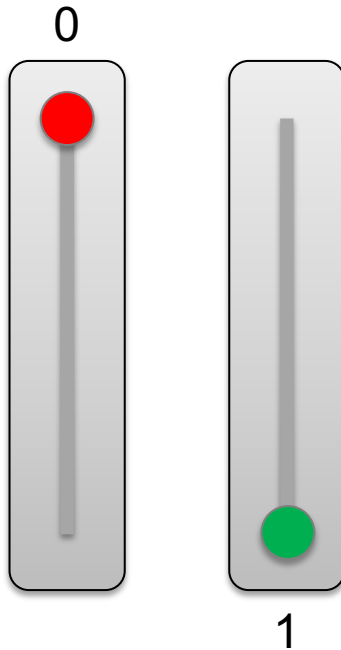

- Quantum bits (qubits)

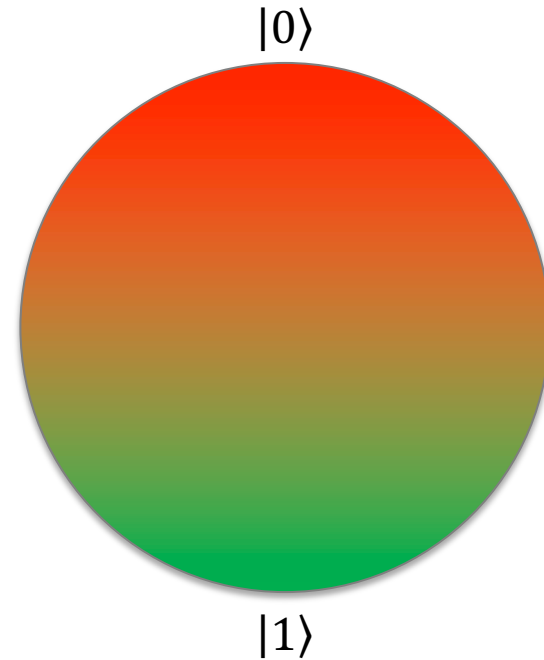

Intermezzo: Schrödinger's cat

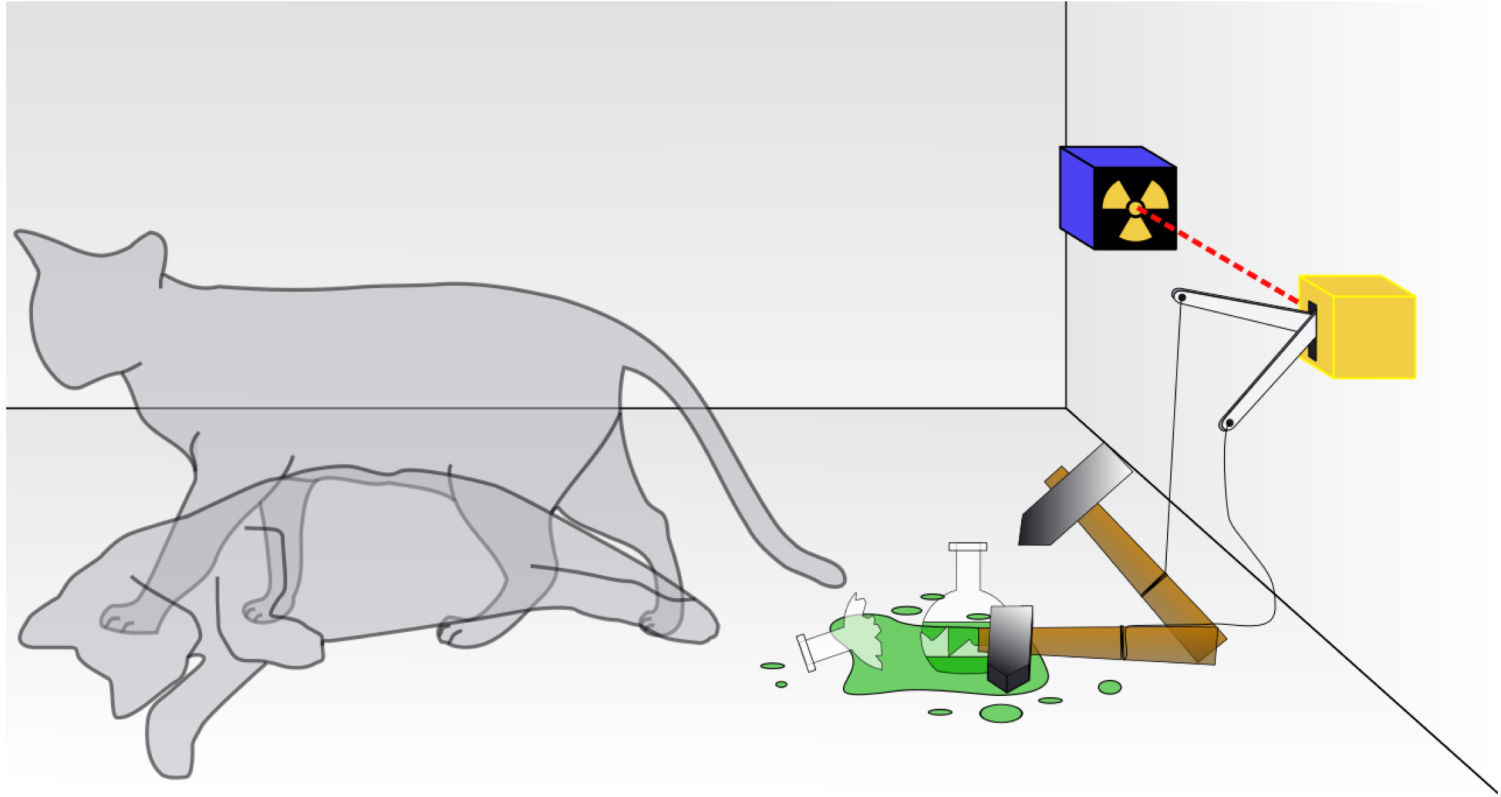

Intermezzo: Schrödinger's cat, cont'd

- Before opening the box

$$\frac{1}{\sqrt{2}}|\text{cat sitting}\rangle + \frac{1}{\sqrt{2}}|\text{cat running}\rangle$$

- After opening the box

$$|\text{cat sitting}\rangle \text{ OR } |\text{cat running}\rangle$$

Intermezzo: Schrödinger's cat, cont'd

- Repeating the experiment many times 50% of the cats are dead, 50% alive

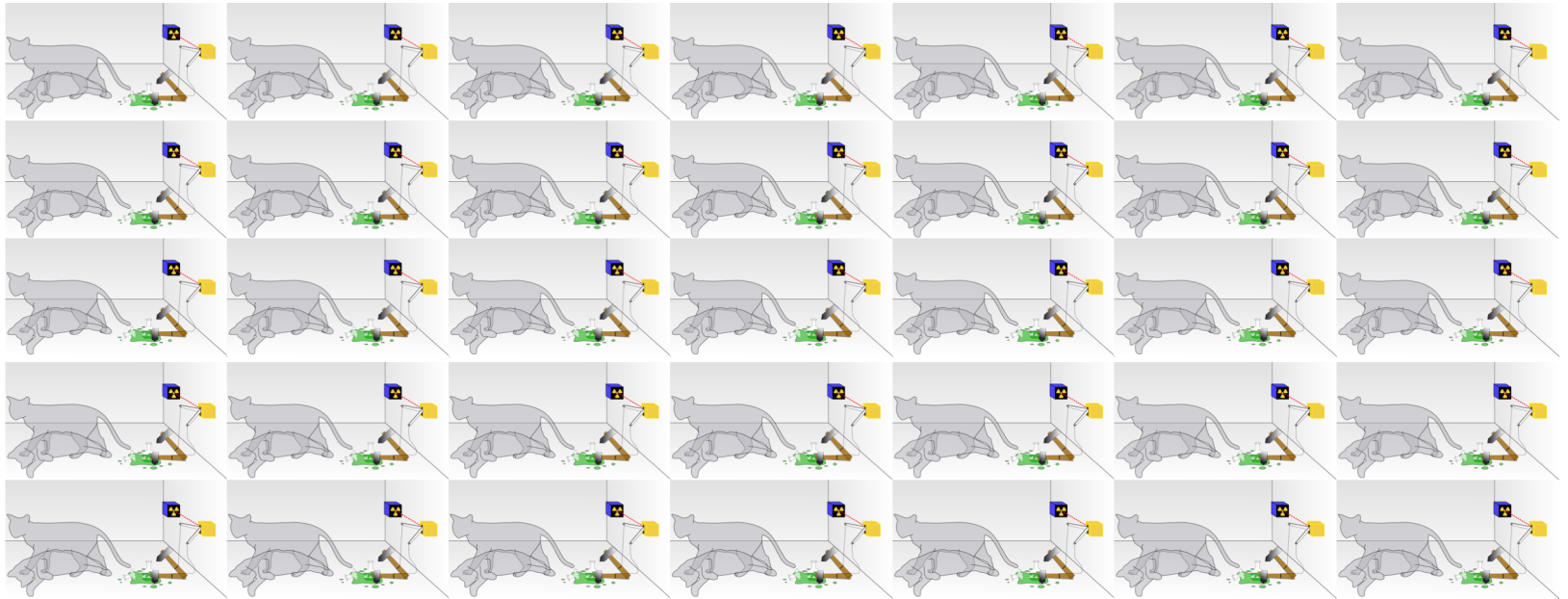

From Bloch's sphere to probabilities

- Coefficients of the basis expansion

$$|\psi\rangle = \cos\frac{\theta}{2} \cdot |0\rangle + e^{i\varphi} \cdot \sin\frac{\theta}{2} \cdot |1\rangle$$



1:16

represent the **probability amplitude** that the quantum state $|\psi\rangle$ collapses to either of the two basis states $|0\rangle$ or $|1\rangle$ upon **measurement** since

$$\left| \cos\frac{\theta}{2} \right|^2 + \left| e^{i\varphi} \cdot \sin\frac{\theta}{2} \right|^2 = 1$$

for all latitudes $\theta \in [0, \pi]$ and longitudes $\varphi \in [0, 2\pi)$

Life of Phi

- Initialization into pure state $|0\rangle$
- Travelling on Bloch's sphere
- Collapsing to either $|0\rangle$ or $|1\rangle$

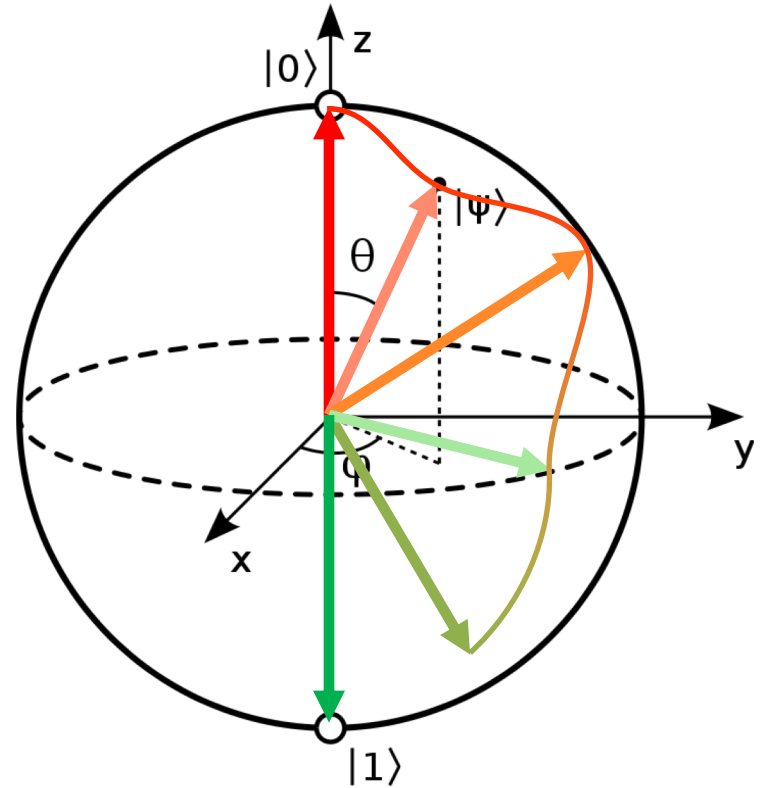

Life of Phi

- Initialization into pure state $|0\rangle$
- Travelling on Bloch's sphere
- Collapsing to either $|0\rangle$ or $|1\rangle$
- *How to describe the travelling?*

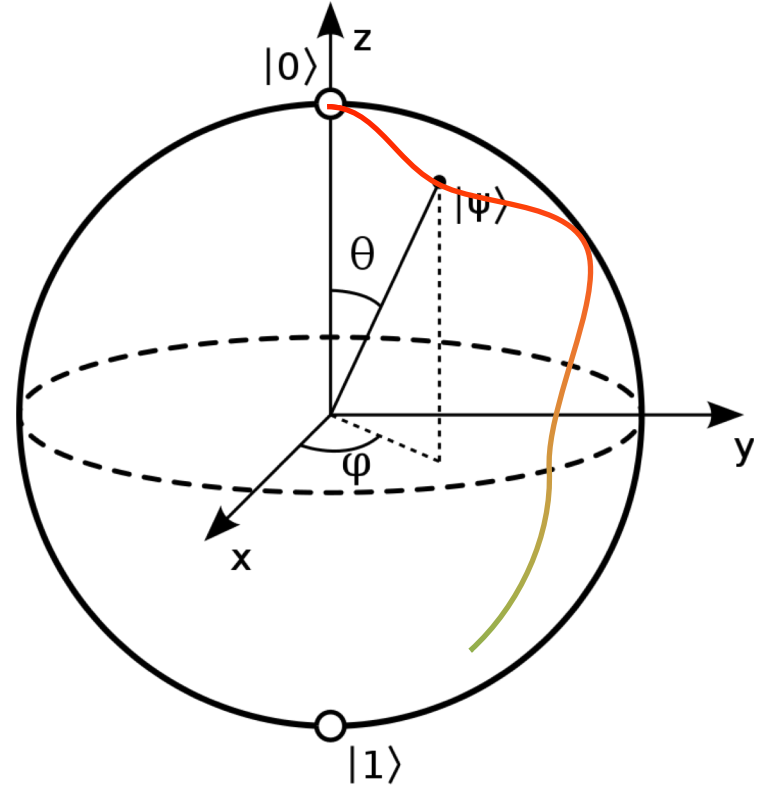

Basic concepts of quantum computing

QUANTUM GATES

Detour to linear algebra

- Unique basis state labels

$$\begin{pmatrix} 1 \\ 0 \end{pmatrix} := |0\rangle, \quad \begin{pmatrix} 0 \\ 1 \end{pmatrix} := |1\rangle$$

- Probability amplitudes

$$\alpha_0 := \cos \frac{\theta}{2}, \quad \alpha_1 := e^{i\varphi} \cdot \sin \frac{\theta}{2}$$

- Yet another representation of a single quantum state

$$|\psi\rangle = \alpha_0 \begin{pmatrix} 1 \\ 0 \end{pmatrix} + \alpha_1 \begin{pmatrix} 0 \\ 1 \end{pmatrix} = \begin{pmatrix} \alpha_0 \\ \alpha_1 \end{pmatrix}$$

Detour to linear algebra, cont'd

- Initialization into pure state

$$|\psi\rangle = 1 \cdot \begin{pmatrix} 1 \\ 0 \end{pmatrix} + 0 \cdot \begin{pmatrix} 0 \\ 1 \end{pmatrix} = \begin{pmatrix} 1 \\ 0 \end{pmatrix}$$

- Multiplication with X

$$X \cdot |\psi\rangle := \begin{pmatrix} 0 & 1 \\ 1 & 0 \end{pmatrix} \cdot \begin{pmatrix} 1 \\ 0 \end{pmatrix} = \begin{pmatrix} 0 \\ 1 \end{pmatrix}$$

- Multiplication with X once more

$$X \cdot X \cdot |\psi\rangle := \begin{pmatrix} 0 & 1 \\ 1 & 0 \end{pmatrix} \cdot \begin{pmatrix} 0 \\ 1 \end{pmatrix} = \begin{pmatrix} 1 \\ 0 \end{pmatrix}$$

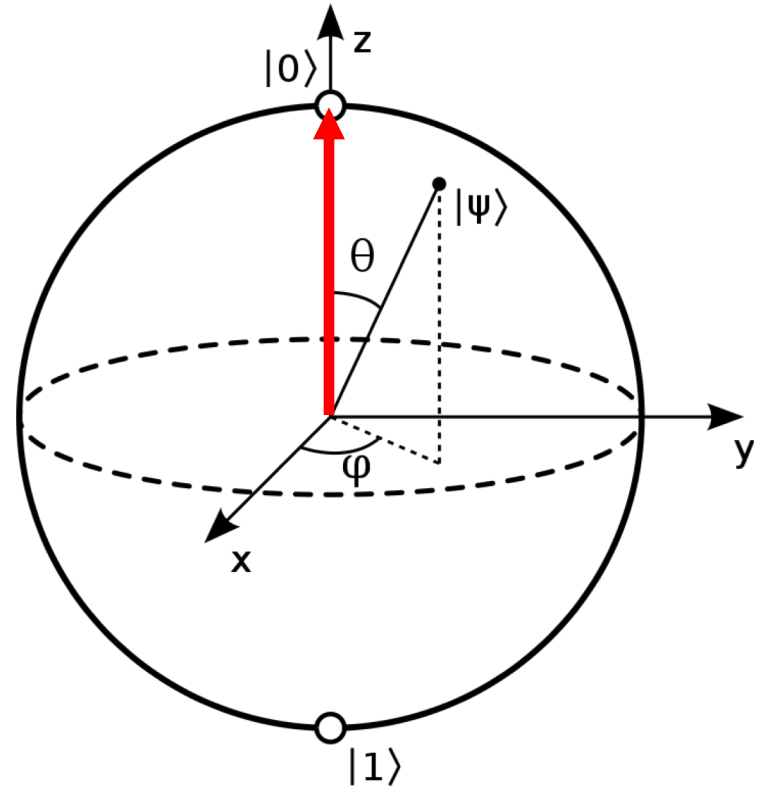

Detour to linear algebra, cont'd

- Initialization into pure state

$$|\psi\rangle = 1 \cdot \begin{pmatrix} 1 \\ 0 \end{pmatrix} + 0 \cdot \begin{pmatrix} 0 \\ 1 \end{pmatrix} = \begin{pmatrix} 1 \\ 0 \end{pmatrix}$$

- Multiplication with another matrix

$$H \cdot |\psi\rangle := \frac{1}{\sqrt{2}} \begin{pmatrix} 1 & 1 \\ 1 & -1 \end{pmatrix} \begin{pmatrix} 1 \\ 0 \end{pmatrix} = \frac{1}{\sqrt{2}} \begin{pmatrix} 1 \\ 1 \end{pmatrix}$$

- Double application of matrix H gives

$$H^2 \cdot |\psi\rangle := \frac{1}{\sqrt{2}} \begin{pmatrix} 1 & 1 \\ 1 & -1 \end{pmatrix} \frac{1}{\sqrt{2}} \begin{pmatrix} 1 \\ 1 \end{pmatrix} = \begin{pmatrix} 1 \\ 0 \end{pmatrix}$$

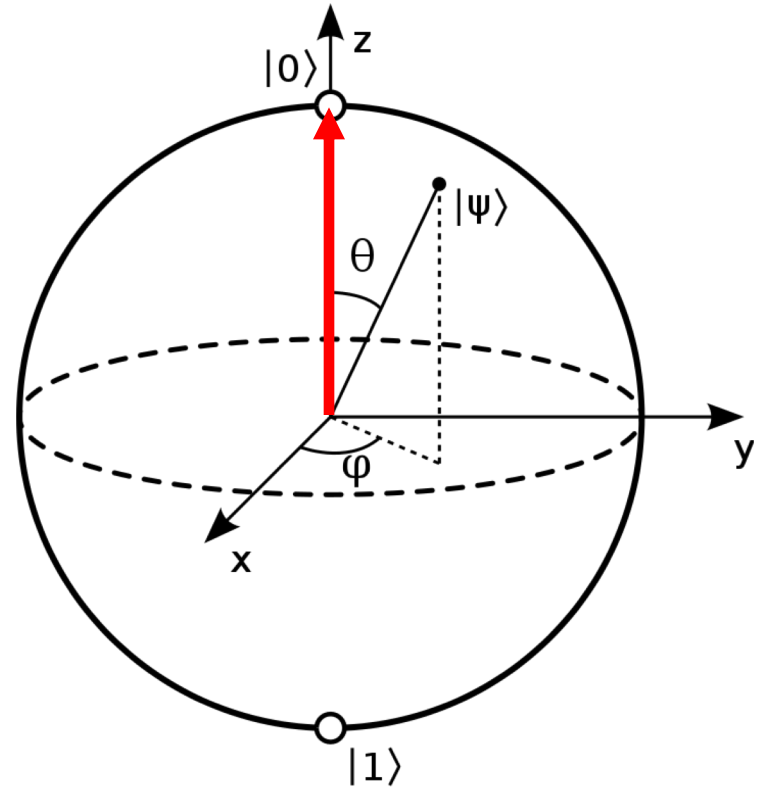

Et voilà, our first quantum algorithm

$$H \cdot X \cdot H \cdot X \cdot \begin{pmatrix} 1 \\ 0 \end{pmatrix} = \begin{pmatrix} 0 \\ -1 \end{pmatrix} = 0 \cdot |0\rangle - 1 \cdot |1\rangle$$

- Quantum circuit

Probability $|-1|^2 = 1$
to measure the **1** state



Quantum Inspire



```
1  version 1.0
2
3  qubits 1
4  prep_z q[0]
5  X q[0]
6  H q[0]
7  X q[0]
8  H q[0]
9  measure q[0]
```

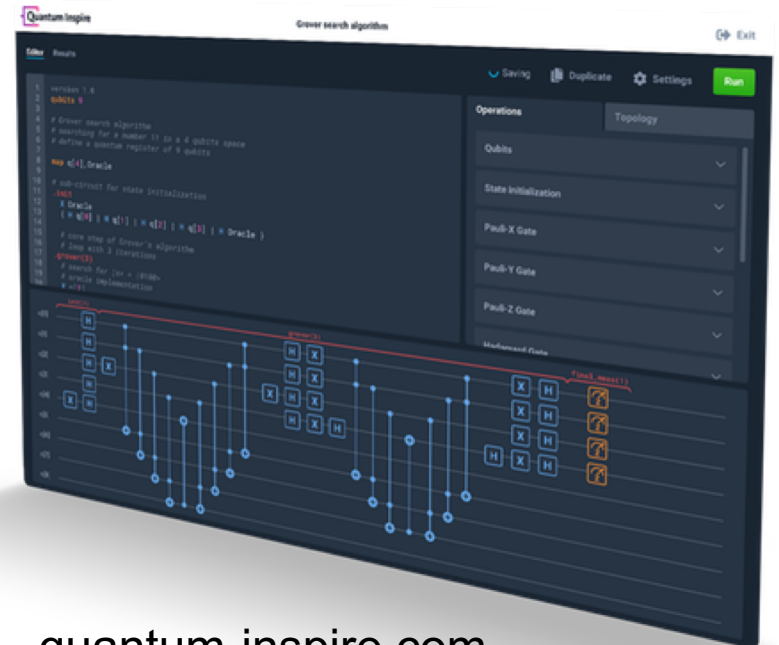

quantum-inspire.com

Basic concepts of quantum computing

QUANTUM ALGORITHMS

Bell state

$$|\beta_{00}\rangle = \frac{1}{\sqrt{2}} \cdot |00\rangle + 0 \cdot |01\rangle + 0 \cdot |10\rangle + \frac{1}{\sqrt{2}} \cdot |11\rangle$$

- 50:50 chance to measure $|0?\rangle$ or $|1?\rangle$
- But then we know the value of the second qubit without measurement since

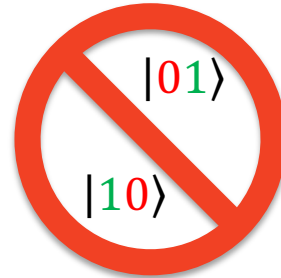

Bell state

$$|\beta_{00}\rangle = \frac{1}{\sqrt{2}} \cdot |00\rangle + 0 \cdot |01\rangle + 0 \cdot |10\rangle + \frac{1}{\sqrt{2}} \cdot |11\rangle$$



Quantum Teleportation

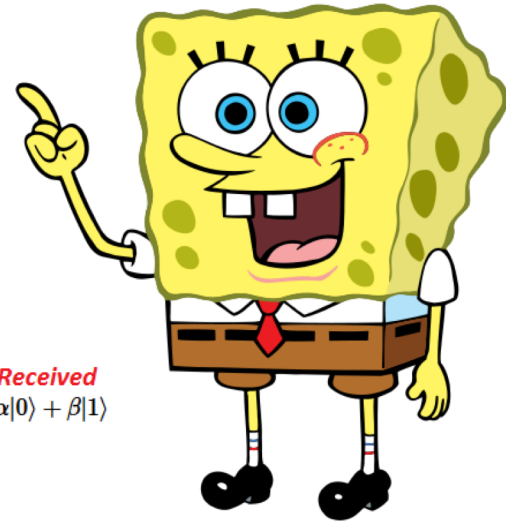
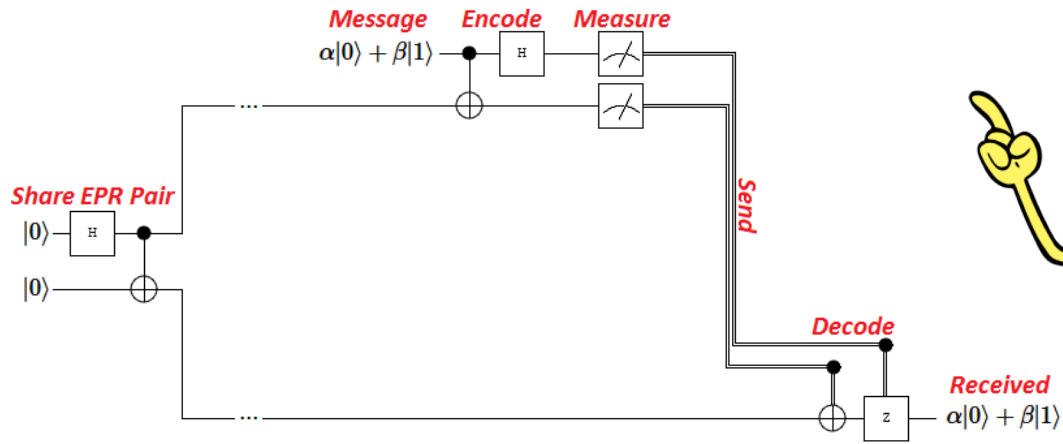

Intermezzo: How difficult can it be to add two integers?

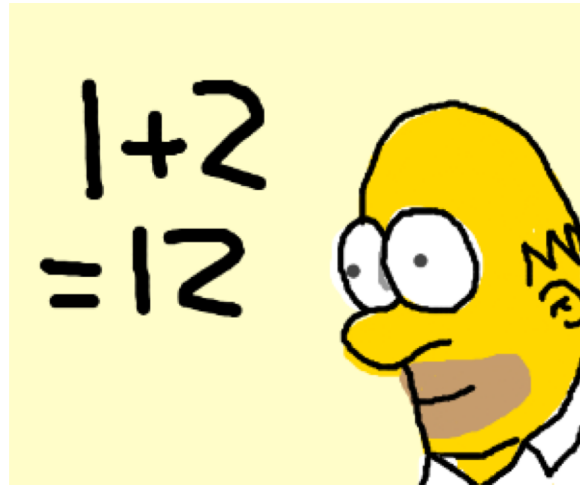

Intermezzo: How difficult can it be to add two integers?

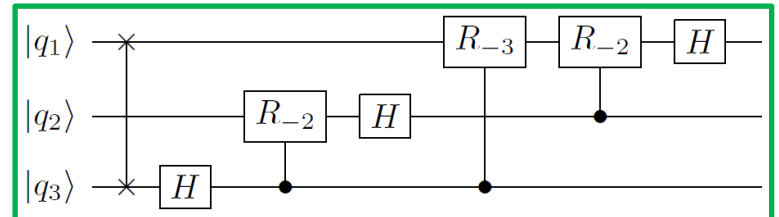
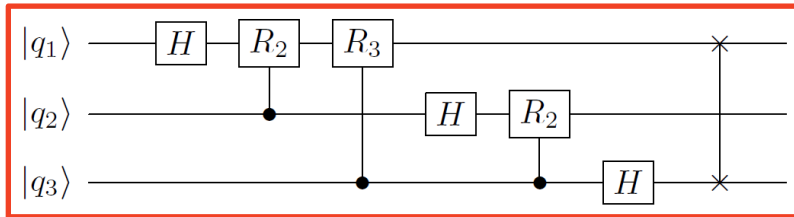
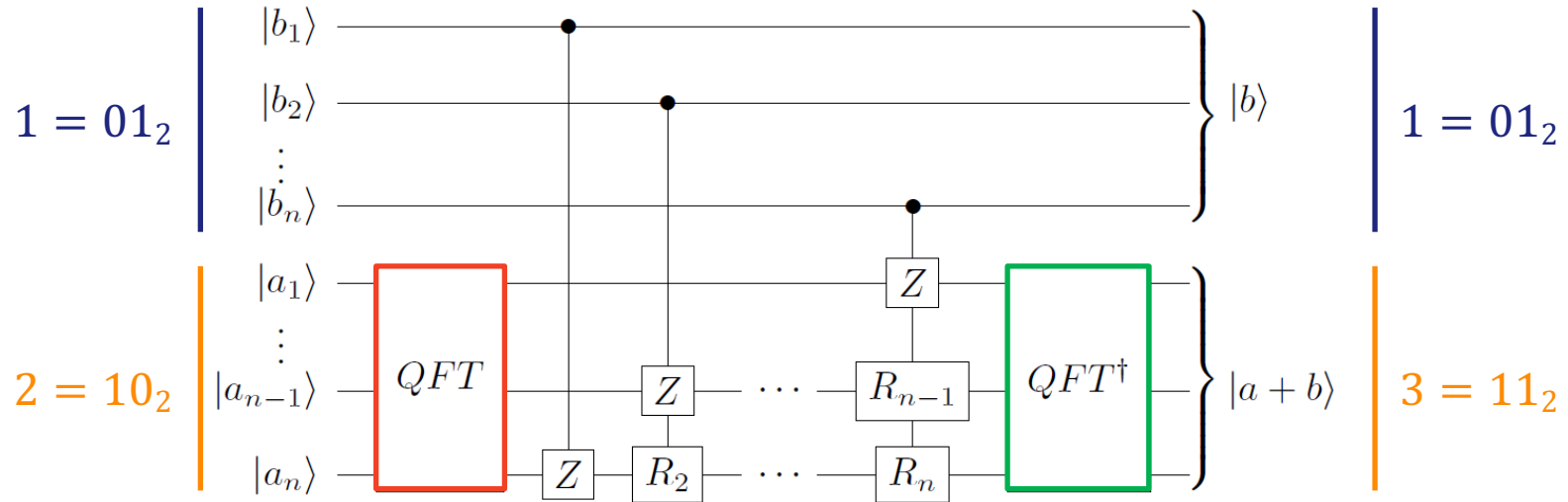

Intermezzo: How difficult can it be to add two integers?

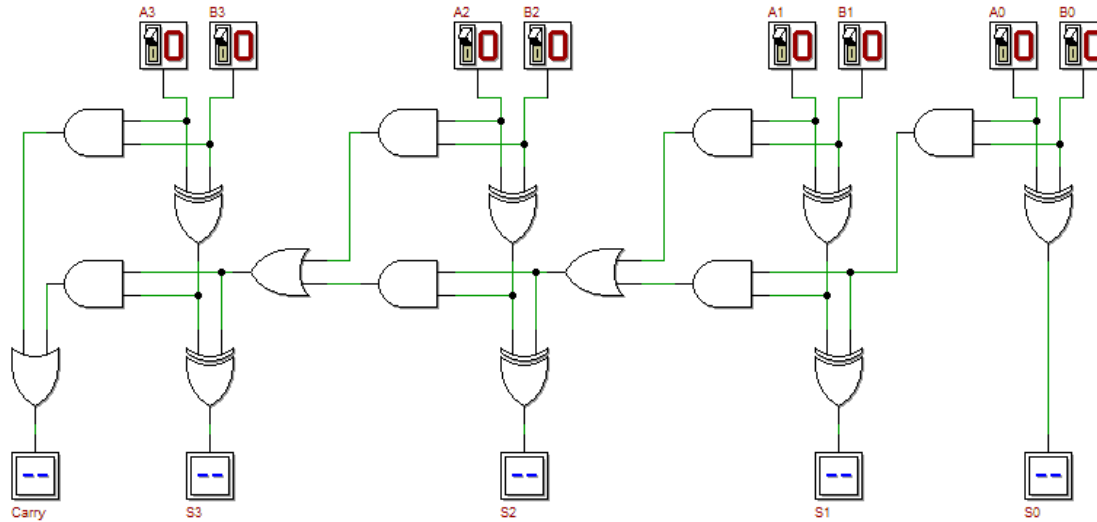

Intermezzo: How difficult can it be to add two integers?

```
def add(a: Int, b: Int) = a + b
```

```
add(1, 2)
```

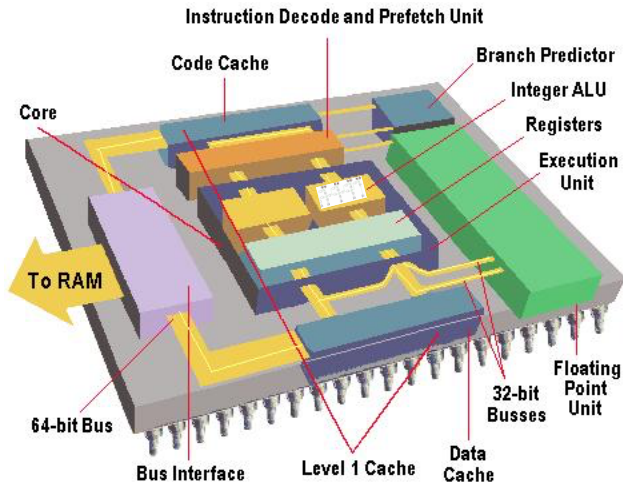

Quantum-accelerated design optimization

CONCEPTUAL FRAMEWORK

Airfoil design

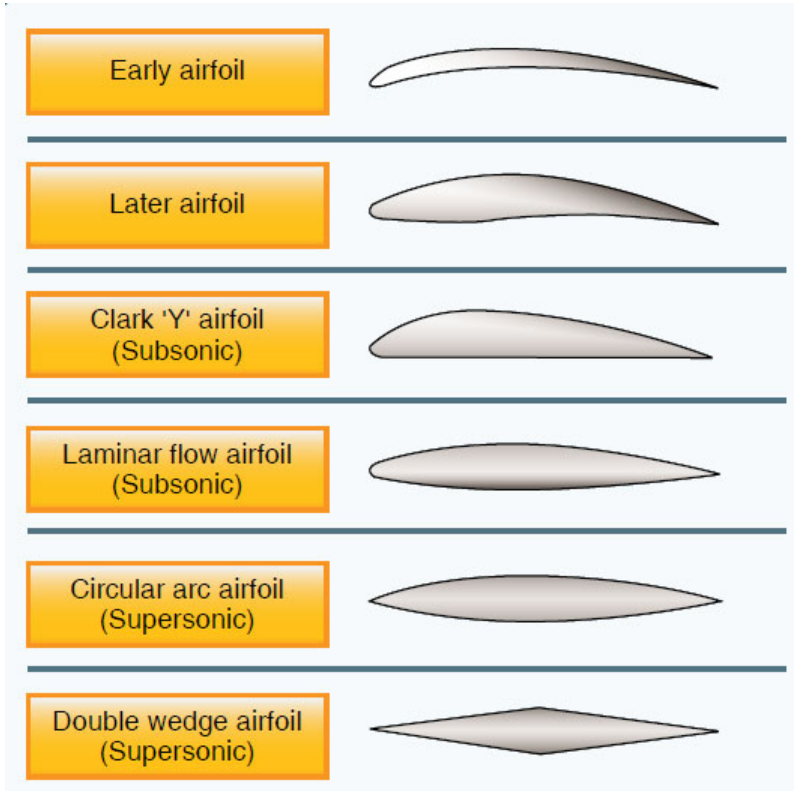

CFInotebook.net



Simulation-based design and analysis cycle

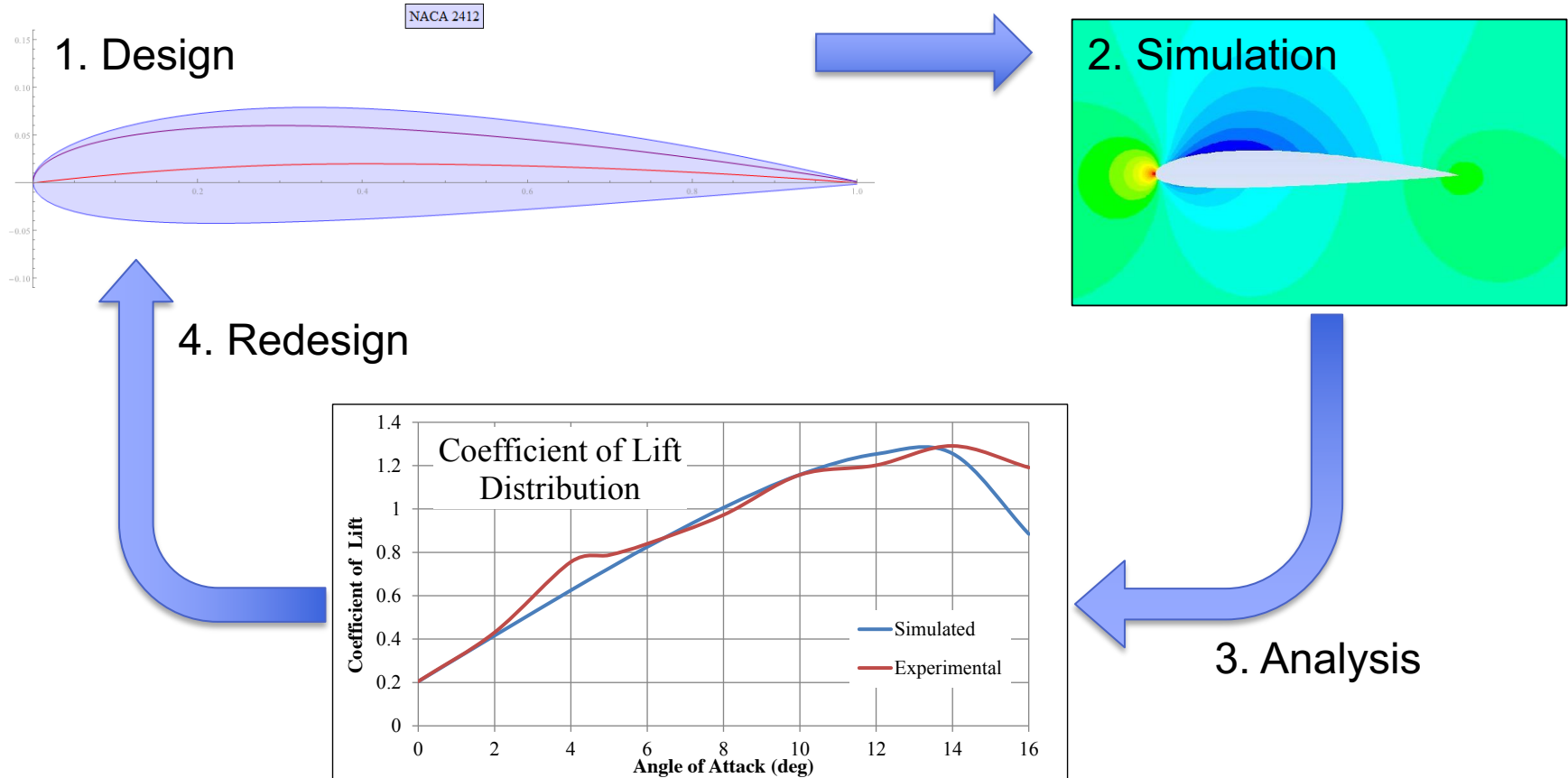

1. Design $D(\mathbf{p})$

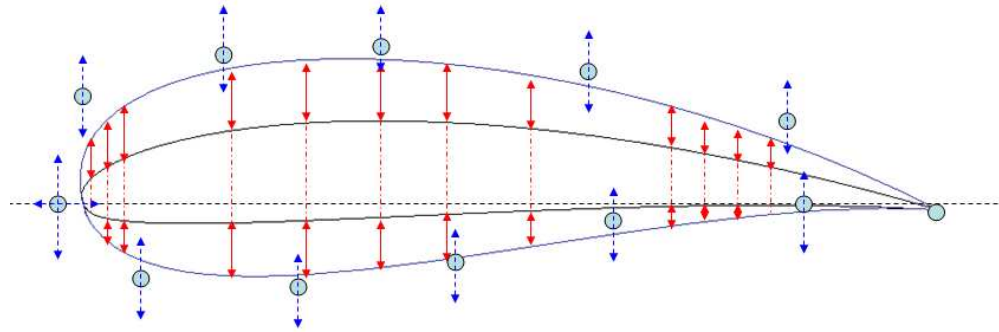

- Design parameters

$$\mathbf{p} = (p_1, \dots, p_{12})$$

- Admissible design space

$$\mathcal{S} = [p_1^{min}, p_1^{max}] \times \dots \times [p_{12}^{min}, p_{12}^{max}]$$

2. Simulation

- Mathematical model



Navier-Stokes Equations 3 - dimensional - unsteady

Glenn
Research
Center

Coordinates: (x,y,z) Time: t Pressure: p Heat Flux: q
 Density: ρ Stress: τ Reynolds Number: Re
 Velocity Components: (u,v,w) Total Energy: Et Prandtl Number: Pr

Continuity:
$$\frac{\partial \rho}{\partial t} + \frac{\partial(\rho u)}{\partial x} + \frac{\partial(\rho v)}{\partial y} + \frac{\partial(\rho w)}{\partial z} = 0$$

X - Momentum:
$$\frac{\partial(\rho u)}{\partial t} + \frac{\partial(\rho u^2)}{\partial x} + \frac{\partial(\rho uv)}{\partial y} + \frac{\partial(\rho uw)}{\partial z} = -\frac{\partial p}{\partial x} + \frac{1}{Re_r} \left[\frac{\partial \tau_{xx}}{\partial x} + \frac{\partial \tau_{xy}}{\partial y} + \frac{\partial \tau_{xz}}{\partial z} \right]$$

Y - Momentum:
$$\frac{\partial(\rho v)}{\partial t} + \frac{\partial(\rho uv)}{\partial x} + \frac{\partial(\rho v^2)}{\partial y} + \frac{\partial(\rho vw)}{\partial z} = -\frac{\partial p}{\partial y} + \frac{1}{Re_r} \left[\frac{\partial \tau_{xy}}{\partial x} + \frac{\partial \tau_{yy}}{\partial y} + \frac{\partial \tau_{yz}}{\partial z} \right]$$

Z - Momentum:
$$\frac{\partial(\rho w)}{\partial t} + \frac{\partial(\rho uw)}{\partial x} + \frac{\partial(\rho vw)}{\partial y} + \frac{\partial(\rho w^2)}{\partial z} = -\frac{\partial p}{\partial z} + \frac{1}{Re_r} \left[\frac{\partial \tau_{xz}}{\partial x} + \frac{\partial \tau_{yz}}{\partial y} + \frac{\partial \tau_{zz}}{\partial z} \right]$$

Energy:
$$\frac{\partial(E_T)}{\partial t} + \frac{\partial(uE_T)}{\partial x} + \frac{\partial(vE_T)}{\partial y} + \frac{\partial(wE_T)}{\partial z} = -\frac{\partial(u p)}{\partial x} - \frac{\partial(v p)}{\partial y} - \frac{\partial(w p)}{\partial z} - \frac{1}{Re_r Pr_r} \left[\frac{\partial q_x}{\partial x} + \frac{\partial q_y}{\partial y} + \frac{\partial q_z}{\partial z} \right]$$

$$+ \frac{1}{Re_r} \left[\frac{\partial}{\partial x} (u \tau_{xx} + v \tau_{xy} + w \tau_{xz}) + \frac{\partial}{\partial y} (u \tau_{xy} + v \tau_{yy} + w \tau_{yz}) + \frac{\partial}{\partial z} (u \tau_{xz} + v \tau_{yz} + w \tau_{zz}) \right]$$

- Solution for one particular design

$$U = U(D(\mathbf{p}))$$

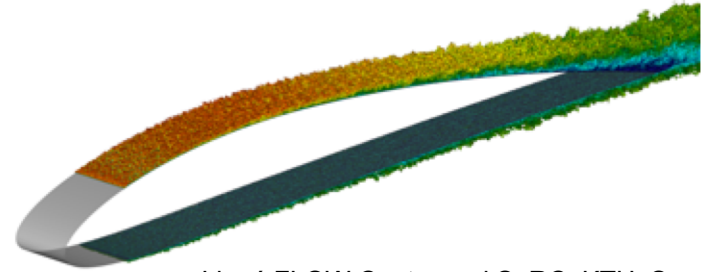

Linné FLOW Centre and SeRC, KTH, Sweden

3. Analysis

- Cost functional

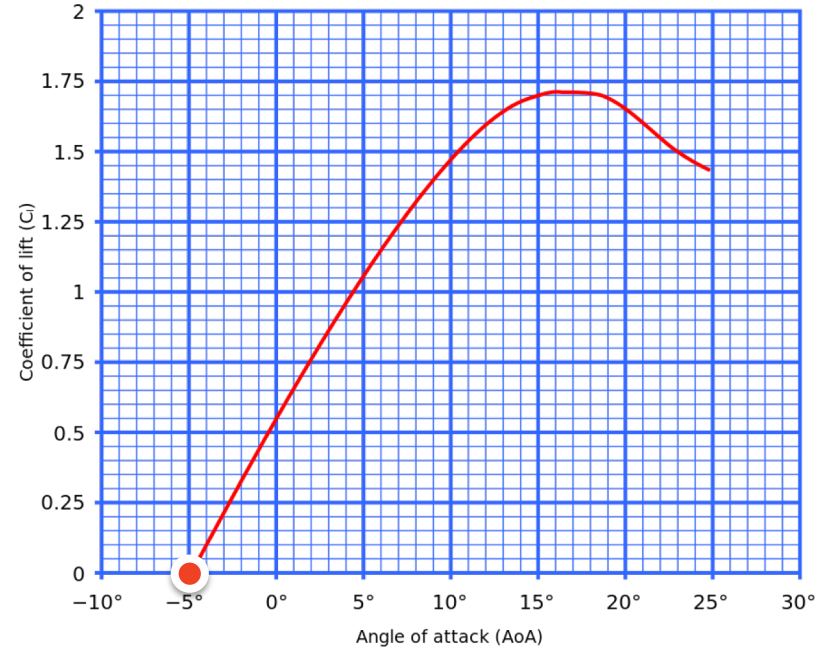
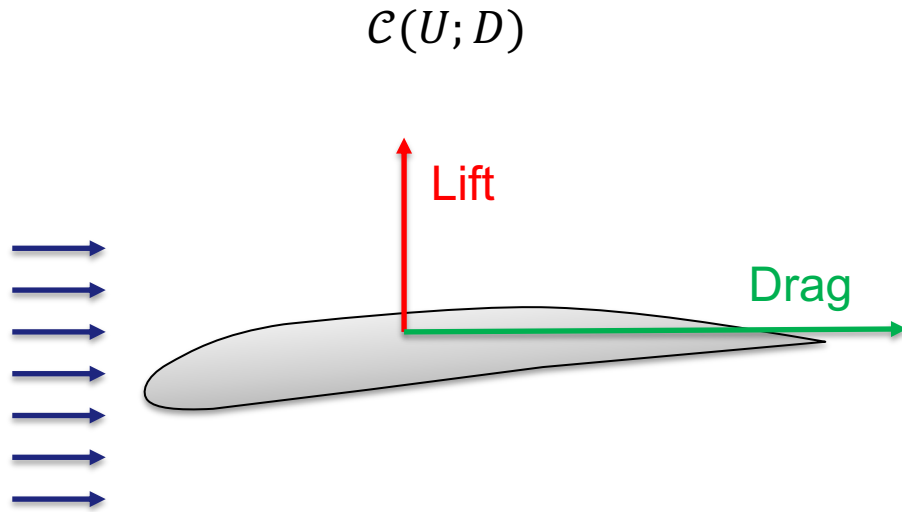

Operation conditions



Abstract design optimization

- **Problem:** Find a set of admissible design parameters \mathbf{p} such that solution $U(D(\mathbf{p}))$ to the mathematical model $\mathcal{M}(U, D(\mathbf{p}))$ computed on the design $D(\mathbf{p})$ optimizes the cost functional $\mathcal{C}(U, D(\mathbf{p}))$ for fixed operation condition



Abstract design optimization

- **Problem:** Find a set of admissible design parameters \mathbf{p} such that solution $U(D(\mathbf{p}))$ to the mathematical model $\mathcal{M}(U, D(\mathbf{p}))$ computed on the design $D(\mathbf{p})$ optimizes the cost functional $\mathcal{C}(U, D(\mathbf{p}))$ for fixed operation condition



A conceptual framework for quantum accelerated automated design optimization

Matthias Möller^{a,*}, Cornelis Vuik^a

^aDelft University of Technology, Delft Institute of Applied Mathematics (DIAM), Van Mourik Broekmanweg 6, XE Delft 2628, The Netherlands

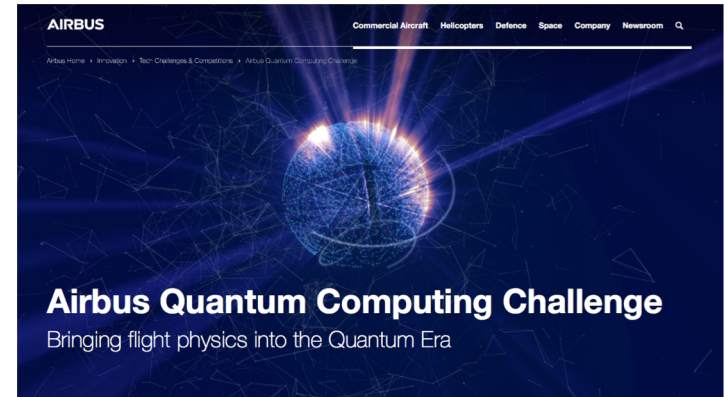

Academic model problem

- *Change circumstances*



“should be”



“is”



Academic model problem

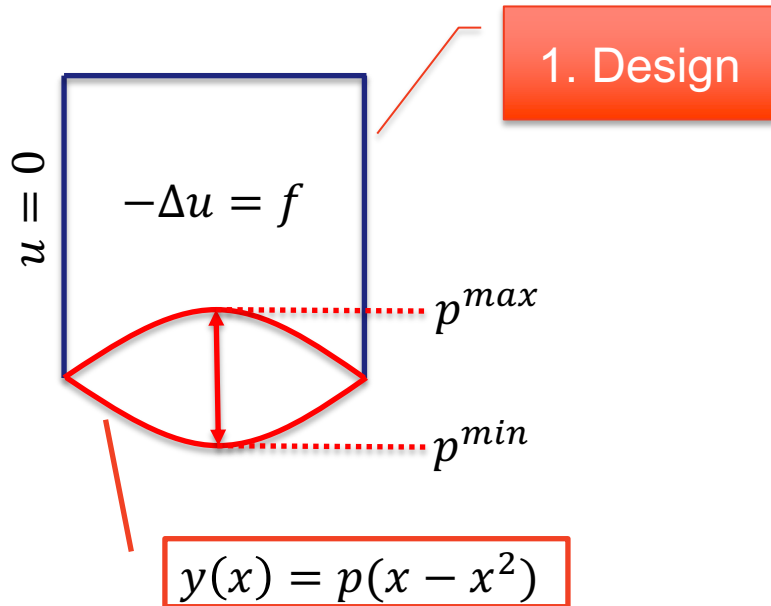

- **Problem:** Minimize the difference

$$d_h = u_h - u_h^*$$

between the solution u_h and a given profile u_h^* w.r.t.

3. Analysis

$$\mathcal{C}(d_h, p) = d_h^T M d_h$$

such that d_h solves

2. Simulation

$$A_h d_h = f_h - A_h u_h^*$$

4. Redesign

Quantum acceleration

- Best classical solution algorithm

$$\mathcal{O}(N s \kappa \log(1/\epsilon))$$

- Quadratic form optimizer

$$\mathcal{O}((\# \text{design parameters})^2)$$

- Quantum Linear Solver Algorithm

- HHL: $\mathcal{O}(\log(N) s^2 \kappa^2 / \epsilon)$

- Ambainis: $\mathcal{O}(\log(N) s^2 \kappa / \epsilon)$

- Jordan's QOPT

$$\mathcal{O}((\# \text{design parameters})^1)$$

Quantum speed-up

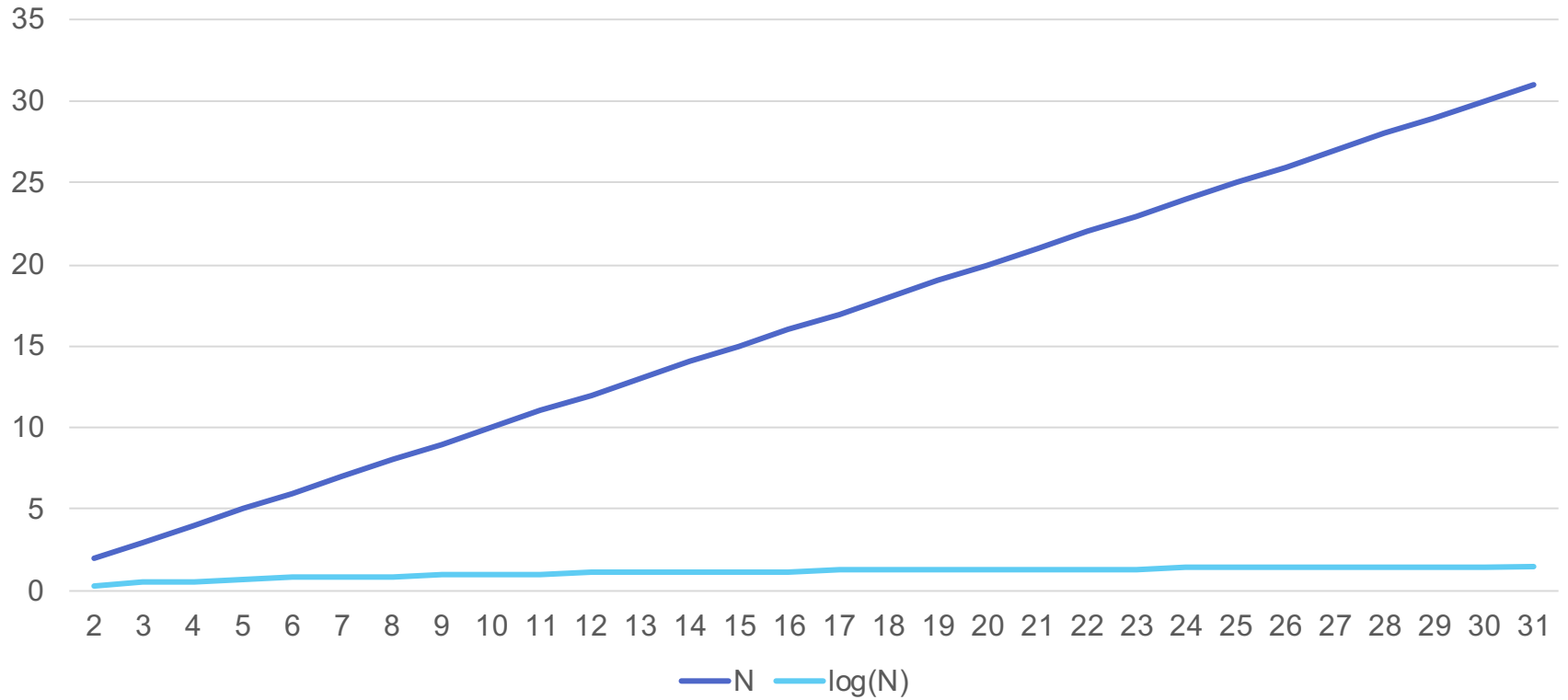

Quantum speed-up (?)

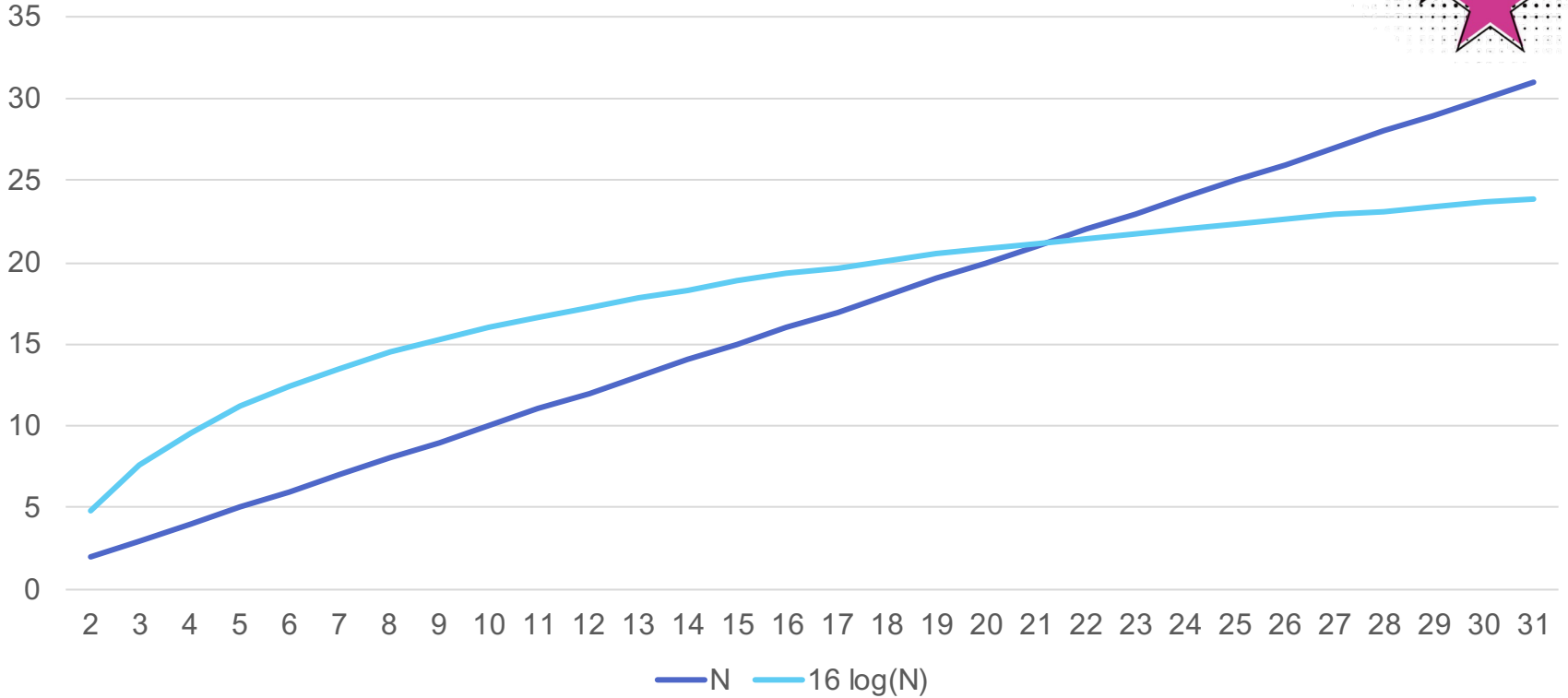

Quantum speed-up (?)

Rigetti 128
Google 72
Intel 49

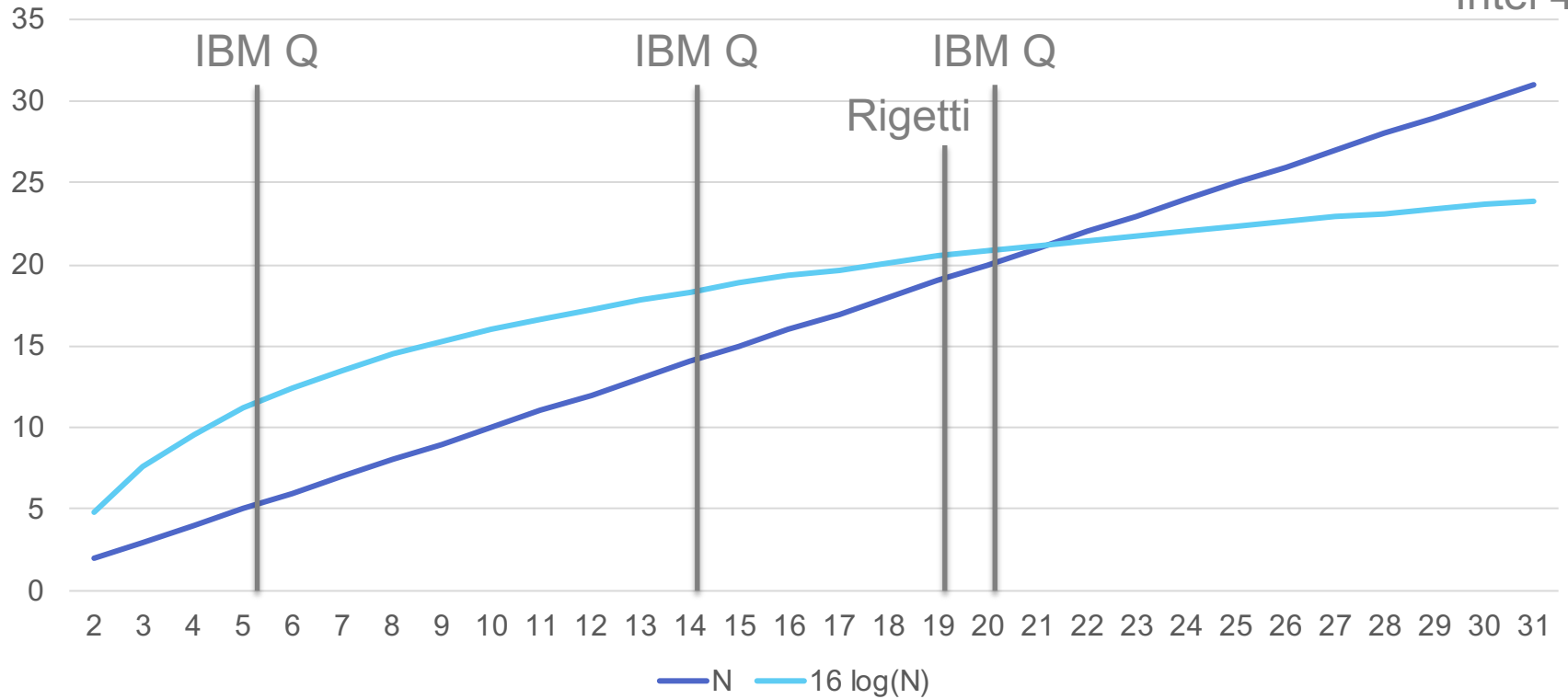

Practical aspects of quantum computing

SDKS AND GOOD PRACTICES

How accelerated computing works

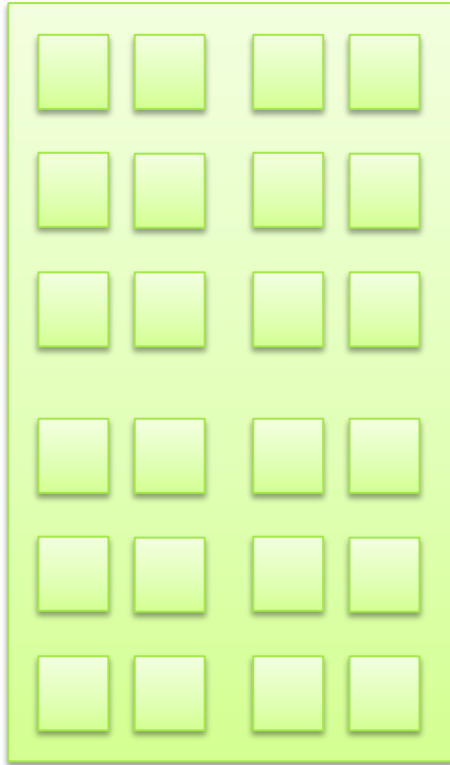

Accelerator

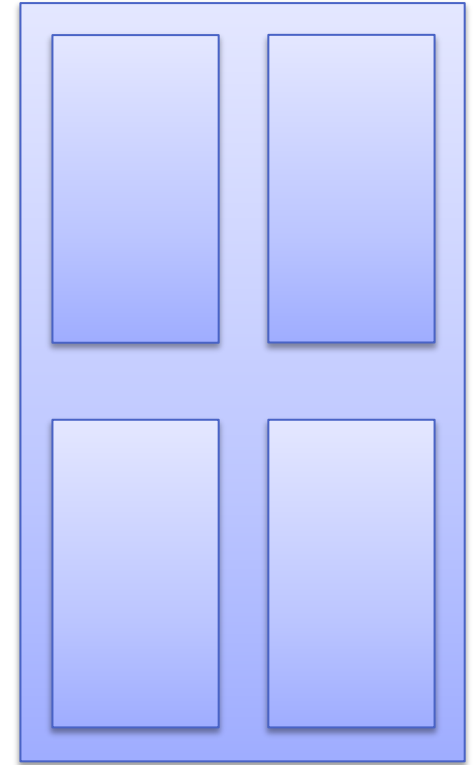
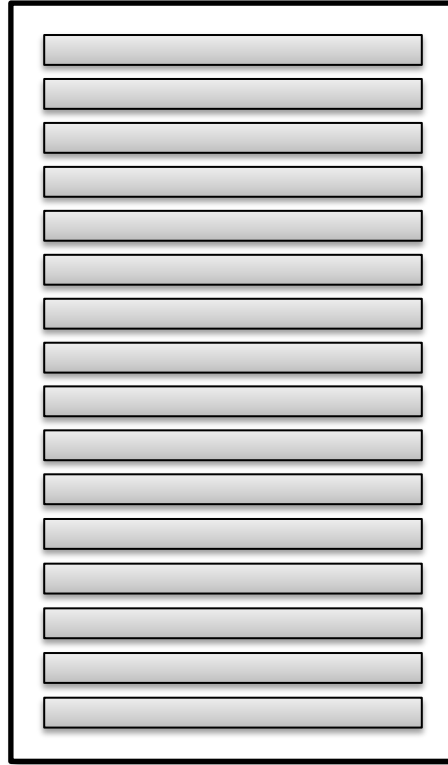

Host

How accelerated computing works

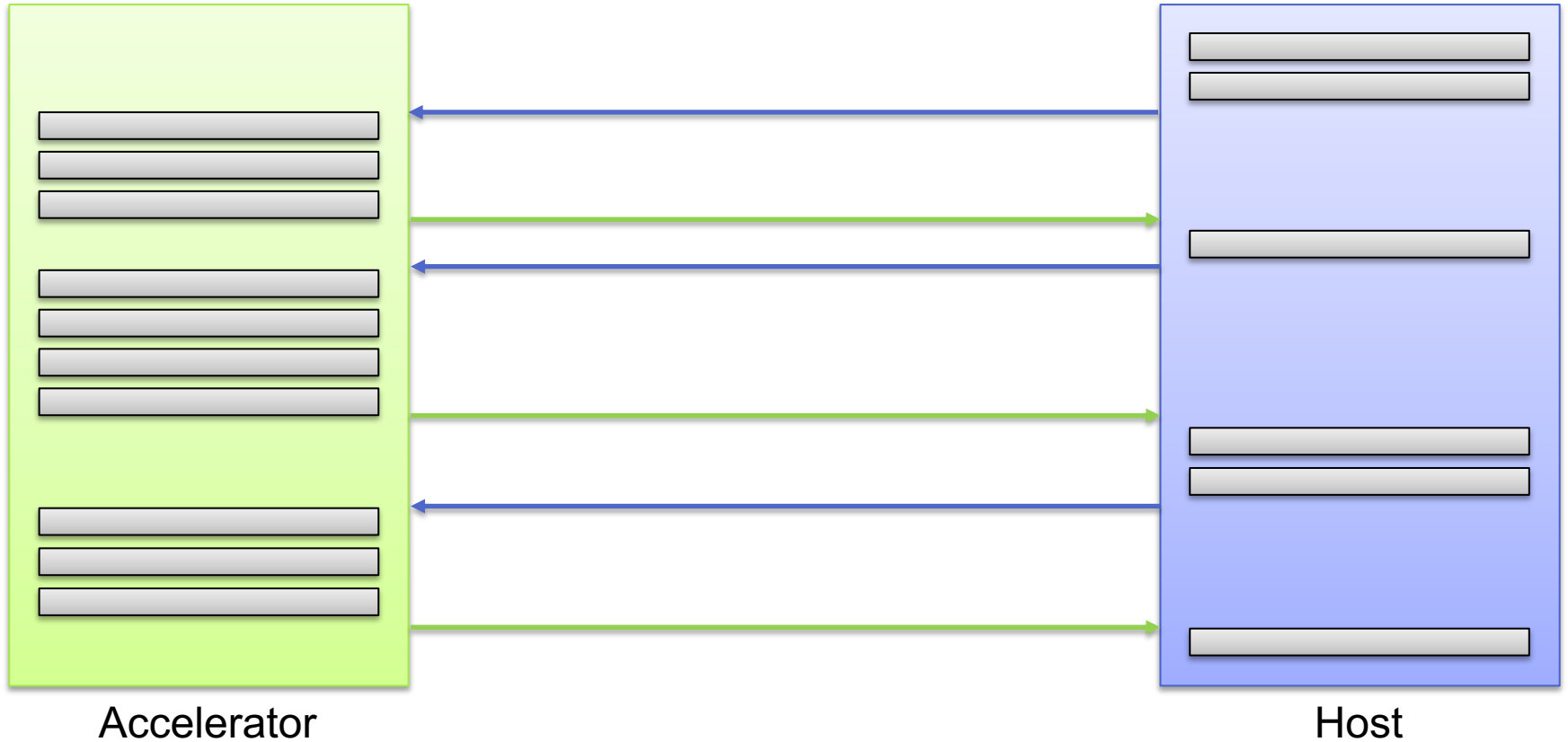

How accelerated computing works

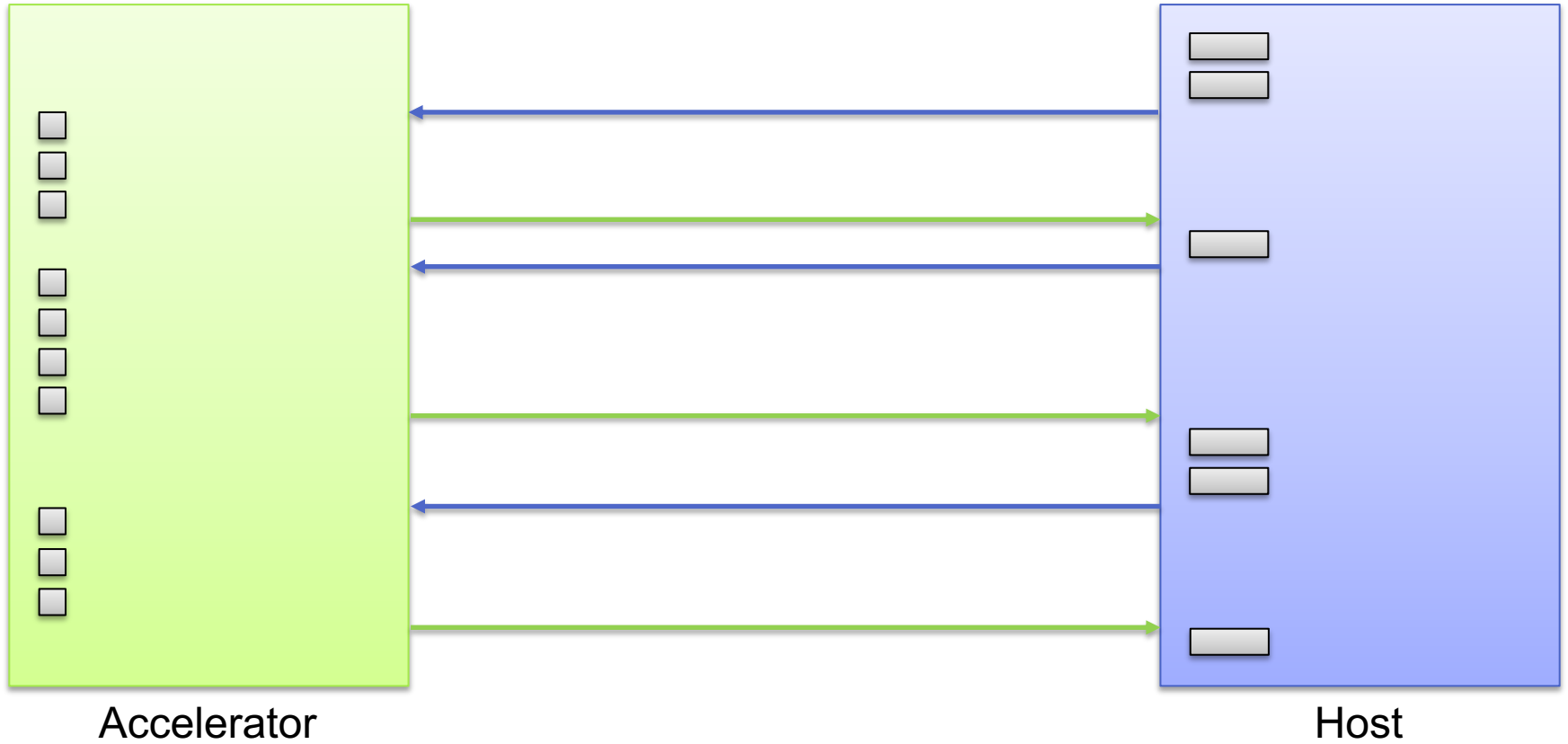

How accelerated computing works

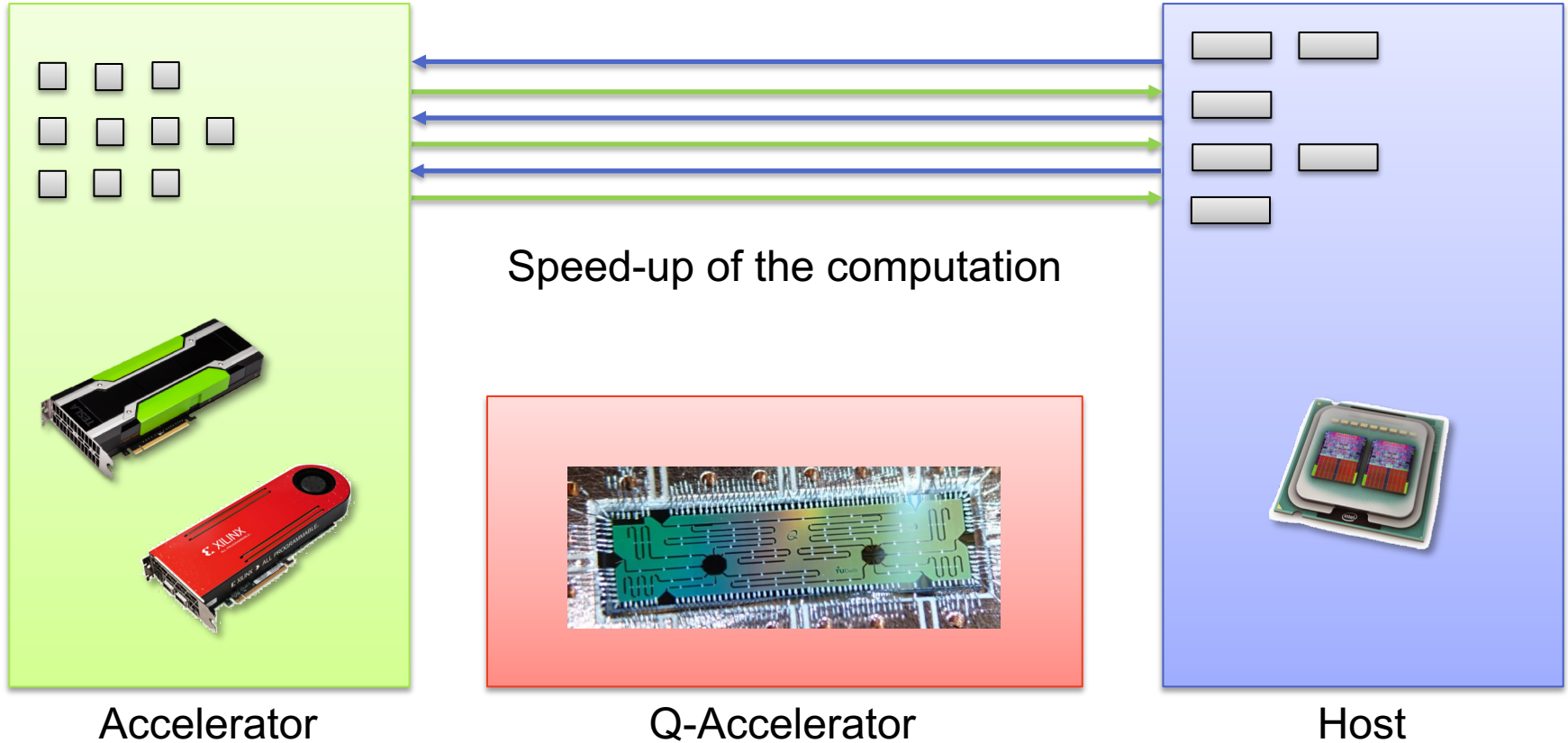

It feels like GPU-computing in the early 2000

- Quantum languages
 - AQASM: Atos QML
 - cQASM: QuTech QX, TNO QI
 - OpenQASM: IBM, Google
 - Quil: Rigetti
 - ...
- Quantum SDKs
 - pyAqasm
 - pyQuil
 - Circ
 - OpenQL/QX
 - ProjectQ
 - QisKit
 - Quantum Development Kit
 - Quirk
 - ...

It feels like GPU-computing in the early 2000

Algorithm	pyQuil	Qiskit	ProjectQ	QDK
Random Bit Generator	✓(T)	✓(T)	✓(T)	✓(T)
Teleportation	✓(T)	✓(T)	✓(T)	✓(T)
Swap Test	✓(T)			
Deutsch-Jozsa	✓(T)	✓(T)		✓(T)
Grover's Algorithm	✓(T)	✓(T)	✓(T)	✓(B)
Quantum Fourier Transform	✓(T)	✓(T)	✓(B)	✓(B)
Shor's Algorithm			✓(T)	✓(D)
Bernstein Vazirani	✓(T)	✓(T)		✓(T)
Phase Estimation	✓(T)	✓(T)		✓(B)
Optimization/QAOA	✓(T)	✓(T)		
Simon's Algorithm	✓(T)	✓(T)		
Variational Quantum Eigensolver	✓(T)	✓(T)	✓(P)	
Amplitude Amplification	✓(T)			✓(B)
Quantum Walks		✓(T)		
Ising Solver	✓(T)			✓(T)
Quantum Gradient Descent	✓(T)			
Five Qubit Code				✓(B)
Repetition Code		✓(T)		
Steane Code				✓(B)
Draper Adder			✓(T)	✓(D)
Beauregard Adder			✓(T)	✓(D)
Arithmetic			✓(B)	✓(D)
Fermion Transforms	✓(T)	✓(T)	✓(P)	
Trotter Simulation				✓(D)
Electronic Structure (PCI, MP2, HF, etc.)			✓(P)	
Process Tomography	✓(T)	✓(T)		✓(D)
Vaidman Detection Test		✓(T)		

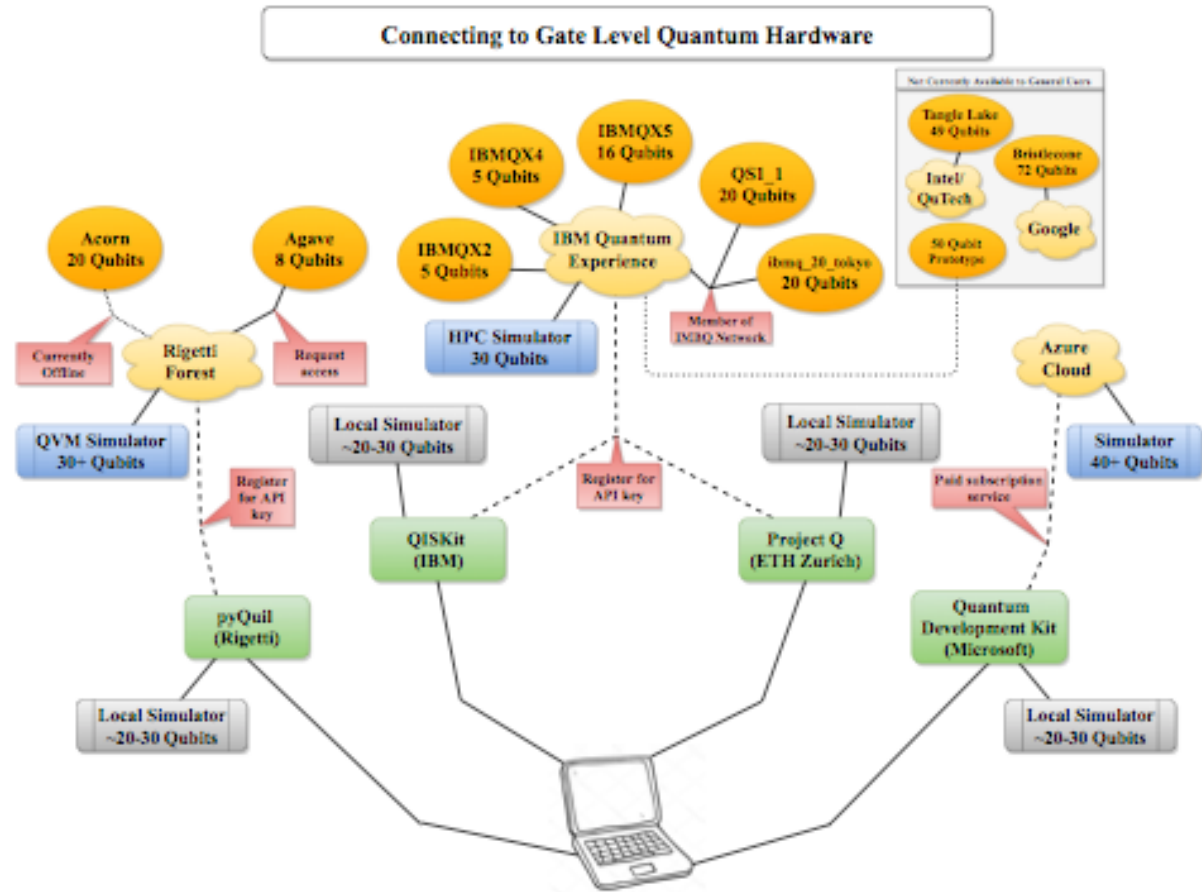

$|\text{LIB}\rangle$: Kwantum expression template LIBrary

- Header-only C++14 library
- Open-source release by summer
- Auto-generation of quantum code from C++ expression templates
- Bi-directional communication between host and quantum device
- Made for quantum-accelerated *scientific* computing



|LIB⟩: Kwantum expression template LIBrary

```
auto expr = measure(h(x(h(x(init())))));
```

```
Qdata<1, OpenQASMv2> backend;
```

```
json result = expr(backend).execute();
```

```
QInt<3> a(1);
```

```
QInt<3> b(2);
```

```
a += b;
```

Conclusion

- Quantum computers have huge potential as **special-purpose accelerators** to speed-up the solution of (mathematical) problems ‘exponentially’
- Convergence towards **common quantum programming language** and **development toolchain** needed to make end-users interested (if at all!)
- To fully exploit the power of quantum computers don’t mimic classical algorithms but **redesign quantum algorithms from scratch** based on quantum-mechanical principles like **superposition** and **entanglement**

Thank you very much!